

DATASHEET

# FlexiBowl® 500 C/CC

Flexible feeding system for all parts measuring between **5** and **50 mm** and weighing up to **100 g**

FlexiBowl® 500C/CC can feed products of any geometry, surface and material. It is compatible with all industrial robots and vision systems. One FlexiBowl® can feed entire ranges of parts measuring 5 to 50 mm and weighing up to 100 g, replacing the need for the numerous units used in conventional systems.



ADVANTAGES

- High performance
- Compatible with 99.9% of parts
- Maximum load 7 kg
- Essential design, robust construction
- Cleanroom option (ISO 5)
- Remote-controlled electronics for dirty environments
- Rapid, intuitive integration
- Several singulation options
- Accurate location of parts
- Suitable for delicate parts
- Large area for singulation and picking
- Quick emptying option
- Patented
- Low maintenance

HOW IT WORKS

Parts dropping, singulation and picking take place simultaneously in dedicated sectors. For greater productivity. In FlexiTrack, all four operations take place simultaneously.

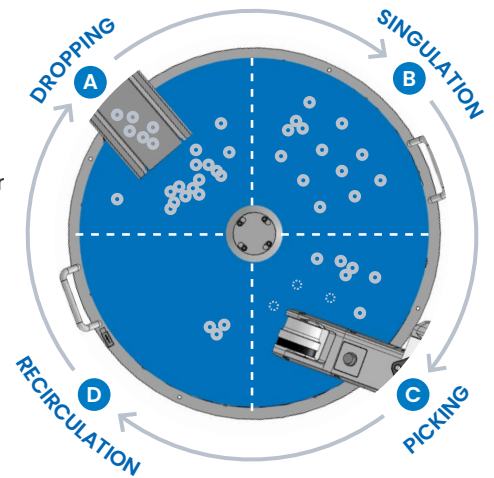

OPERATING MODES

**Traditional**

Parts are singulated by the **combined action of bidirectional** rotation and the pulse generator. Once the parts are separated, the robot uses the coordinates sent by the vision system to locate and pick them up, while the disc is not moving.

PRECISION	■■■■■	LAYOUT	■■■
PERFORMANCE	■■■■■	EASY TO INTEGRATE	■■■■■
SINGULATION	■■■■■		

**FlexiTrack**

FlexiTrack enables **circular conveyor tracking** of the FlexiBowl®. In the FlexiTrack mode, the vision system operates in the sector just ahead of the robot picking area; processing for the vision system and the robot is simultaneous.

PRECISION	■■■■■	LAYOUT	■■■■■
PERFORMANCE	■■■■■	EASY TO INTEGRATE	■■■■■
SINGULATION	■■■■■		

**Multiple Parts Feeding**

This mode permits simultaneous feeding of different parts. One FlexiBowl® can reliably **handle up to 6 different part types**, minimizing layout and production costs.

PRECISION	■■■■■	LAYOUT	■■■■■
PERFORMANCE	■■■■■	EASY TO INTEGRATE	■■■■■
SINGULATION	■■■■■		

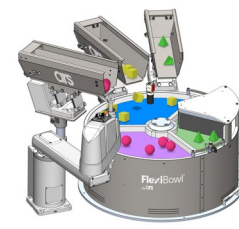

DATASHEET

# FlexiBowl® 500 C/CC

Flexible feeding system for all parts measuring between **5** and **50 m** and weighing up to **100 g**

## SPECIFICATIONS

Dimensions of parts	5<x<50mm
Weight of parts	<100g
Backlit area	475cm2
Load capacity	7 kg
Bulk feeder/hopper load capacity	10/20 dm3
Overall dimensions	Ø640 mm
Picking height	270 mm
Installation temperature	0-45 °C
Installation position	A pavimento
Weight of mechanical assembly	25 Kg
Air pressure (dry and filtered)	6 bar - tubo Ø 6mm
Electronic power supply	110-230 Vac
Red backlight wavelength	630nm
Infrared backlight wavelength	850nm
Absorption	150W
Data connection	- Ethernet IP - Digital I/O - TCP/IP-UDP - Gateway for other protocols

## DIMENSIONS

A	503 mm	G	296 mm
B	533 mm	H	362 mm
C	334 mm	I	28 mm
D	167 mm	L	629 mm
W	556 mm	M	10 mm
F	580 mm	Weight	42 Kg

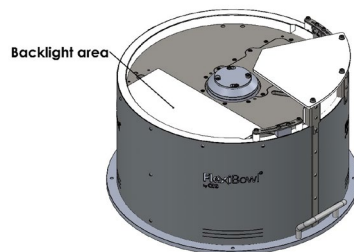
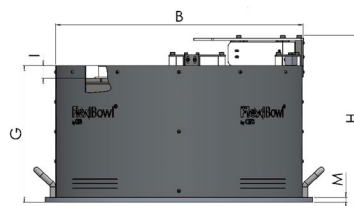
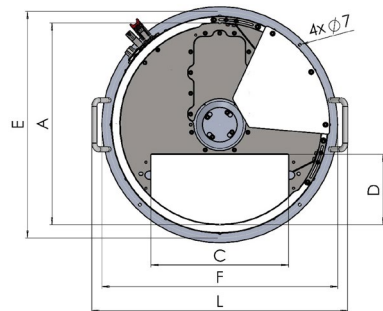

## OPTIONAL ACCESSORIES

- ▶ Analog electro pneumatic regulator
- ▶ Calibration plate
- ▶ Camera bracket base stand
- ▶ Cleanroom version
- ▶ Custom grooved discs
- ▶ Diverters
- ▶ External swivel gripper
- ▶ FlexiTrack
- ▶ Lighting (White, Red, IR)
- ▶ Multiple parts feeding
- ▶ Quick emptying
- ▶ Remote control box
- ▶ Rotary discs (including FDA-compatible and anti-static)

## PLUG-INS

FlexiBowl is compatible with all TCP/IP socket languages and offers plug-ins for a vast range of robots, including:

- ▶ ABB
- ▶ Denso
- ▶ Doosan
- ▶ Epson
- ▶ Fanuc
- ▶ Kawasaki
- ▶ Kuka
- ▶ Mecademic
- ▶ Mitsubishi Electric
- ▶ Omron
- ▶ Stäubli
- ▶ Techman Robot
- ▶ Universal Robots

## PLC PLUG-INS AVAILABLE:

- ▶ Allen – Bradley
- ▶ Omron
- ▶ Siemens

## ROTARY DISC TYPES

Including FDA-compatible and anti-static

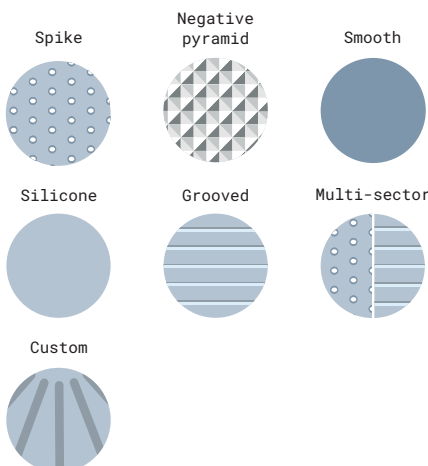

## CONTACTS

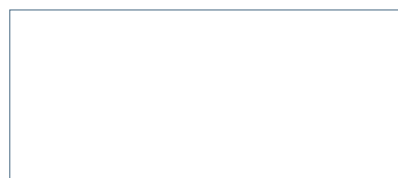

Ars s.r.l.  
Via G. Vico, 7  
52100 Arezzo  
Tel: +39.0575.398611  
P.I. 01739760518  
[sales@arsautomation.com](mailto:sales@arsautomation.com)  
[www.flexibowl.com](http://www.flexibowl.com)

